



Patriot E / Patriot L Operations Manual



Patriot E



Patriot L

Table of Contents

Specifications	3
Hardware Description	4
Serial RS-232/RS-485	4
Trigger Mode	4
Power Requirements	4
Installation	5
Mounting	5
Tag Installation in Vehicles	5
Parallel Surfaces Rule	6
Wiring	7
Wiring Guide	7
Wire Function Table	8
Reader Configuration	9
Factory default Patriot Reader settings	9
Setup Program	9
ICON Buttons – Upper Left Window	10
Reader Information	10
Reader Status	11
Reader Options	12
Control Section	12
Comm	12
Reader Actions	13
RF	13
Reader section	13
Serial Comm Section	14
Wiegand Section	15
Tag Formats	15
Tag Filtering Section	16
Relay	16
Indicators	17
Log Window	17
Wired Ethernet Configuration (E.TCP, L.TCP only)	18
Wi-Fi Configuration (E.WiFi, L.WiFi only)	35
Access Point (Default)	35
Station	36
OSDP Configuration (Patriot E Only)	37
Troubleshooting	38
Do's and Do Not's	39
Warranty	40
Manual Revision History	41

Specifications

	Patriot E	Patriot L
Dimensions	10.7" x 10.7" x 3.7" (272 mm x 272 mm x 94mm)	9.45" x 9.45" x 3.82" (240 x 240 x 97mm)
Supply Voltage	9V ~ 48V DC	
Supply Current	Max 470 mA when idle, max 1.82 A during read	
Antenna	7.5 dBi Circular Polarized	10 dBi Linear-Vertical Polarized
RF Power	10 ~ 30 dBm (adjustable)	
Tag Read Range	Max 18' ~ 25' (5.5 ~ 7.6m), depending on tag type and environment	
RF Frequency	902.75 ~ 927.25 MHz (50 channels) Frequency Hopping Spread Spectrum (FHSS)	
Tag/Credential Types	EMX 900MHz Passive RFID Credentials, Also compatible with Infinity RFID, Nedap, and Rosslare formatted tags Generic passive tags: EPC Class 1, Gen 2; ISO 18000-6C <i>Bluetooth (BLE) Credentials*</i>	
Indicators	LED, audible tone	
Data Output Interfaces	Wiegand, RS-232, 12V Relay Driver, Wi-Fi TCP/IP †, Ethernet TCP/IP‡	
Wiegand output formats	26-bit, 30-bit, 33-bit, 34-bit, 35-bit, 37-bit	
Wiegand Timing Parameters	Default: Pulse width 80µs, pulse period 1600µs (Software configurable)	
Serial data output format	ASCII, HID simulation	
Configuration Interfaces	RS-232, <i>Wi-Fi TCP/IP †, Ethernet TCP/IP‡</i>	
RS-485	Data output, OSDP operation	(N/A)
Tag identification time	< 8.0ms after start of read	
Controller Functionality	Trigger input, 12V Relay driver output, Configurable tag filtering (5 facility codes, 100 ID's)	
Protection	Reverse polarity and overvoltage protection, EMI protected I/O lines	
Firmware Updates	Field-upgradable firmware with setup software	
Other Features	Optional Power over Ethernet (PoE) ‡	
Work / Storage Temperature	-4°F ~ 158°F (-20°C ~ 70°C) / -40°F ~ 185°F (-40°C ~ 85°C)	
Operating Humidity	5% to 95% relative humidity non-condensing	
IP Rating	IP-65	
Certification	FCC Part 15 (FCC ID: Y3D-RED5)	

*Bluetooth credentials only work with E.BLE and L.BLE models

†Wi-Fi output and configuration only available on E.WiFi and L.WiFi models

‡Ethernet output and configuration only available on E.TCP and L.TCP models. PoE available upon special request.

Hardware Description

The Patriot E / Patriot L reader is a fully integrated reader with a built-in antenna packaged in a weather-tight, UV protected housing. The antenna allows it to work in AVI and asset management applications and its programmable triggering modes enable the reader to work in either self-triggering (timed) or external trigger mode. Versatile I/O interfaces enable the Patriot E / Patriot L to work with multiple serial devices and with standard Wiegand controllers.

Serial RS-232/RS-485

The reader outputs tag data over RS-232 and RS-485 (Patriot E only) in standard ASCII or HID serial formats and can be viewed on any ASCII terminal viewer (ex: Tera Term). The RS-232 link is bidirectional and is also used for reader configuration. OSDP can be used over the RS-485 interface (Patriot E Only).

Trigger Mode

When configured for Trigger Mode, the reader will only transmit when the trigger input is active. Otherwise it will be idle, drawing only 450mA (great for solar powered isolated areas). Once the trigger is activated by connecting the input wire to ground, it will take 6mS to start reading tags and outputting tag data.

Power Requirements

The Patriot E / Patriot L comes with a regulated, fixed voltage power supply of +12VDC @ 3A. If the application requires a different supply voltage, the reader accepts +8VDC to +48VDC. The minimum power requirement is 10W.

Installation

The Reader is supplied in a weathertight enclosure for direct outdoor installation or can be placed indoors, such as in a guardhouse.

Mounting

The mounting bracket supplied is designed for mounting the reader on a pole, wood, or concrete structure.

- The bracket should be installed at a minimum height of 5' off the earth's surface and a maximum height of 10'.
- Observe the 18/18 rule: Ensure a minimum of 18" from any metal or concrete surface on all sides.
- Aim the reader toward the zone of desired coverage.

The image below shows how the bracket looks assembled on a pole, with a Patriot E mounted for example. Use a 3/8" (10 cm) wrench to install the bracket.



Tag Installation in Vehicles

Always mount tags vertically whenever possible. This will guarantee the best read range for ALL Patriot readers. Note: Patriot-E readers (round) can read tags both vertical and horizontal orientation, but the best read range will always be vertical orientation. Patriot-L readers (square) are specifically designed to read vertical oriented tags only.

Notes about specific tag mounting locations:

- The most common location is inside the lower driver's side corner of the windshield. Mount the tag at least 2" away from any metal. If the reader is on the passenger side instead of the driver's side, mount the tag on the passenger side.
- Mounting in the upper corners of the windshield is possible but be aware that some windshields have antennas or metal oxide coating for UV tinting in this location that can reduce read range. Test the location using the recommended steps above prior to adhering tag to glass.

- Center mounting near the rear-view mirror is also possible for windshield stickers. Some cars have a “window” here where no metallic oxide coatings is present specifically for mounting RFID tags. Test the location using the recommended steps above prior to adhering tag to glass.
- Hang tags are always hung vertically from the rear-view mirror.
- Less common mounting locations include underneath a side view mirror or on a headlight. Test the location using the recommended steps above prior to adhering tag to vehicle.

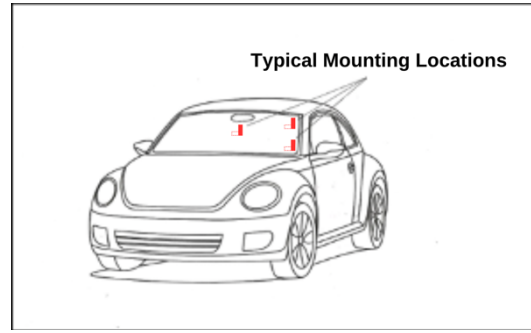
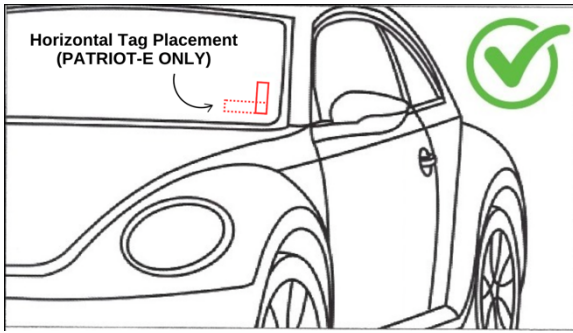

Parallel Surfaces Rule

The Patriot readers are passive RFID systems. The reader provides RF power to the tag, and the tag reflects that RF power back to the reader in order to communicate. To optimize the communication between the reader and the tag, the surfaces of the two should be oriented parallel to one another as much as possible. The following table shows a few pictures of this. Failure to do so will result in reduced read range.

Reader Orientation	Poor tag positioning	Good tag positioning
<p>Reader positioned vertically</p>	<p>A diagram showing a vertical reader on the left and a tag on the right. The tag is tilted at an angle. A red circle with a diagonal slash is overlaid on the scene, indicating this is a poor configuration.</p>	<p>A diagram showing a vertical reader on the left and a tag on the right. Both are oriented vertically and parallel to each other. A double-headed arrow between them indicates good communication.</p>
<p>Reader positioned with a downward tilt</p>	<p>A diagram showing a reader tilted downwards on the left and a tag on the right. The tag is vertical. A red circle with a diagonal slash is overlaid on the scene, indicating this is a poor configuration.</p>	<p>A diagram showing a reader tilted downwards on the left and a tag on the right. The tag is also tilted downwards, parallel to the reader. A double-headed arrow between them indicates good communication.</p>

Wiring

Wiring Guide

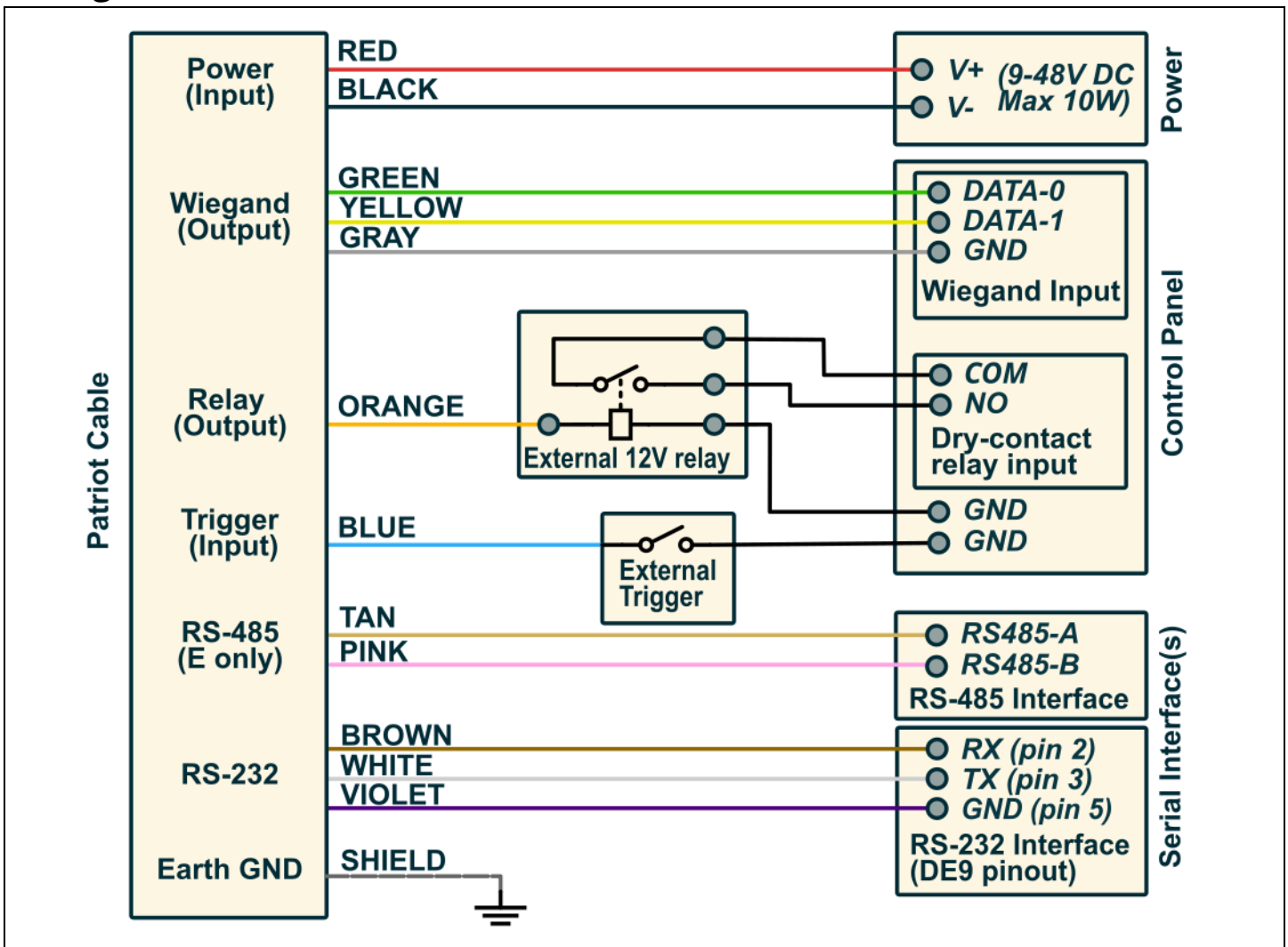

Note: external 12V relay, external trigger, RS-485 interface, and RS-232 interface are not included.

Wire Function Table

Wire	Color	Description
V+	Red	(Required) 8V ~ 48V DC power input.
V- *	Black	Note: Internally, V- is connected to Earth wire and other GND wires.
Wiegand GND *	Gray	Wires used for Wiegand output. When a tag with encoded Wiegand data is read, that data will be output on these wires. Note: do not wire any other devices on the same Wiegand wires as the Patriot reader
Wiegand D0	Green	
Wiegand D1	Yellow	
RS-232 GND *	Violet	Wires used for RS-232 configuration and output.
RS-232 RX	Brown	If using a 9-pin DB9 connector, the white wire goes to pin 3, the brown wire goes to pin 2, and the violet wire goes to pin 5.
RS-232 TX	White	
RS-485A	Tan	(Patriot E only) Wires used for RS-485 communication
RS-485B	Pink	
Trigger	Blue	Timed mode (default): this wire is ignored. Triggered mode: the reader will read when the Trigger wire is connected to GND, and idle otherwise. (Trigger signal can be extended using setup software)
Relay	Orange	Relay driver output. Whenever a valid tag is read, a +12VDC pulse is generated on this wire that can be used to drive the coil of a 12V relay. (max load 700mA)
Shield/Earth *	Uninsulated	Earth ground

* V-, Wiegand GND, RS-232 GND, and Shield/Earth are all connected internally. At least one of these wires MUST be directly connected to a control panel GND connection, or else certain interfaces may not work properly.

10watts' Power Wire Chart in feet for TRES Readers										
voltage	8awg	10awg	12awg	14awg	16awg	18awg	20awg	22awg	24awg	26awg
5vDC@2A	458	298	183	115	71	46	29	17	11	7
12vDC@0.84A	1100	715	440	275	170	110	70	40	26	16
24vDC@0.42A	2200	1430	880	550	340	220	140	80	52	32
48vDC@0.21A	4400	2860	1760	1100	680	440	280	160	104	64

Reader cabling requirements shall be:

1. Cable distance: (Wiegand): 500 feet (150m); RS-232 50 feet (15m); RS-485 4000 feet (1200m); Ethernet 328 feet (100m).
2. Cable type: twisted pairs #22 AWG w/overall shield for both Wiegand, RS-232/485, and CAT5 for Ethernet. Additional conductor will be required for trigger and other control functions. Do not run data cables in same conduit with high voltage lines.

Reader Configuration

Factory default Patriot Reader settings

Setting	Patriot E	Patriot L
Radio Power	25dBm, or optimum for read range	
Timing	Timed mode / 0.25s timed interval / 0.0s trigger extension	
Serial RS-232	RS-232 baud rate 115200 / ASCII mode	
Serial RS-485	Baud rate: 115200 / Protocol: CRLF	(N/A)
Wiegand	Output Mode(s): Wiegand+Serial / Output Buffer: 2.00s Wiegand Pulse Width: 80µs / Wiegand Pulse Period: 1600µs	
Tag Formats	EMX only	
Tag Filtering	Disabled	
Relay	Enabled / hold time: 1.00s	
Indicators	Audio: enabled / LED: enabled / LED hold time: 0.20s	
Wi-Fi (L.WiFi, E.WiFi)	Wifi Mode: Access Point / IP: 192.168.123.1 / Port: 5100 AP SSID: readernet / AP Password: reader123	
Ethernet (L.TCP, E.TCP)	IP: 192.168.1.130 / Gateway: 192.168.1.1 Netmask: 255.255.255.0 / Port: 5100	



Setup Program

This portion of the document details how to communicate and configure the **Patriot E / Patriot L**. To use the setup software as described in this section, the reader must be powered on and connected via RS-232.

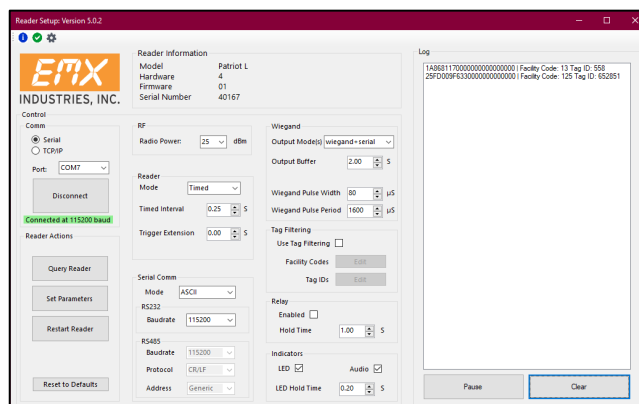
[Click here](#)¹ to download the latest version of the setup software from our website. The setup software includes a multitude of configuration settings to configure the reader for a variety of different applications. Each of these settings are described in the section below.



¹ All downloads and documentation can be found at: www.emxaccesscontrolsensors.com
EMX Industries, Inc. Tech support: 216-518-9889
Document No. 10430104 Rev 1.4 technical@emxinc.com

-  : Information Button, reader specific information
-  : Status Button, reader connection and temperature
-  : Options Button, open tag display and update firmware



ICON Buttons – Upper Left Window

The information contained in this window is:

1. Reader model number
2. Reader serial number
3. Hardware and Software version number
4. PCBA and firmware revision number
5. If OSDP is turned on
6. Radio type

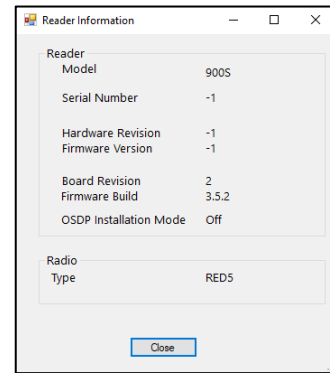

Reader Information

The information contained in this window is:

1. Reader radio device connected
2. Reader RFID processor type
3. RED5 Health, reconnection attempts and resets
4. RF module temperature
5. PCBA temperature
6. RFID processor Maximum Temperature seen
7. PCBA maximum temperature, under Microprocessor
8. Maximum power level the unit was set to
9. Lowest read tag timing
10. If the TCP/IP option installed
11. If the Wi-Fi option installed

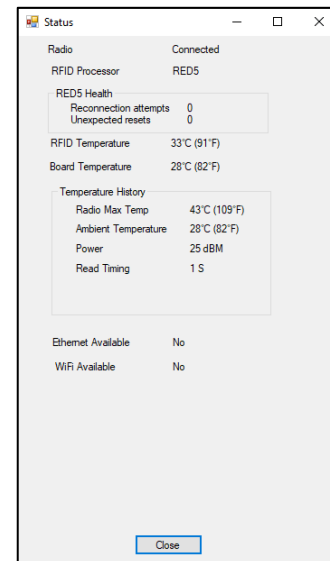

 **Reader Status**

The information contained in this window is:

1. **Open Tag Display:** Opens a window displaying the FC and ID of the tags being read.
2. **Reader IP Address List:** Edit the list of IP addresses used by the setup software for connecting to readers
3. **Set IP Address:** Changes the network settings of the connected reader
4. **Update Firmware:** contact EMX for support

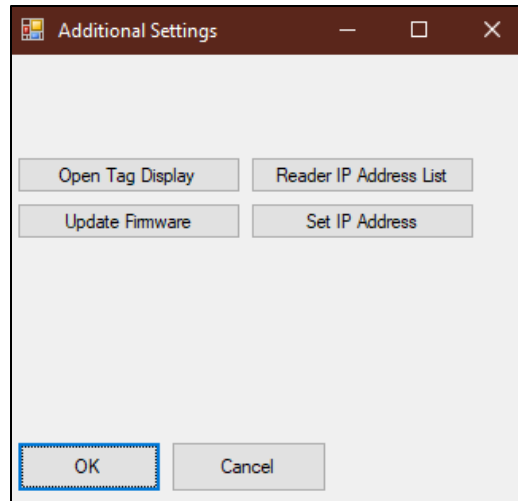

Reader Options

Control Section

This section is used to establish communication with the Patriot E / Patriot L reader and issue basic commands. You may first want to do a Device Manager lookup on your computer to see what COM PORT you are using to connect to the reader with.

Comm

Upon power up, the **Patriot E / Patriot L** will search for available communication devices. Select the appropriate **Comm Port** device from the drop-down menu to connect your computer to the reader, then press the **Connect** button. If you have the TCP/IP option, you can also select it here. When connected, you will get the screen that states that you are connected. A **Query** is done during the connection process. When finished using the setup program, just press the **Disconnect** button. **If you plug in your serial device after starting this software, that device will not be recognized; you will have to shut down the setup program, then restart the setup program to recognize your communications port.**

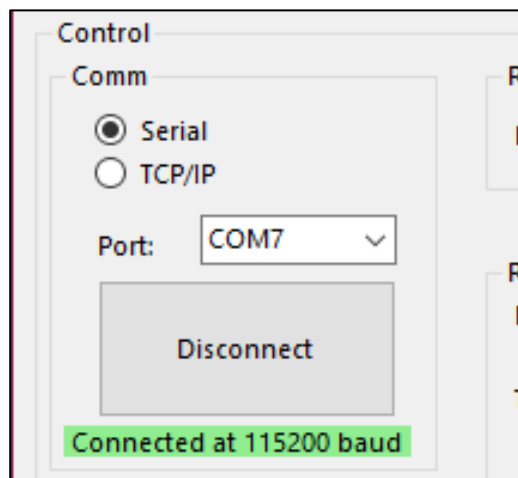

Reader Actions

Query Reader: Retrieve the currently stored settings from the Reader. A Query is also performed automatically when the setup software first connects to the Reader.

Set Parameters: This button updates the Reader with any changes, storing them to flash memory. Changes aren't finalized until this button is pressed.

Restart Reader: Restarts the Reader (instead of having to remove power).

Reset to Defaults: Restores all settings to the factory default mode.



RF

Radio Power: Adjusts how much power the RFID reader uses when reading tags. Higher power typically results in higher tag read range, but can cause issues in enclosed spaces where interference and multipathing may result in less consistent reads.

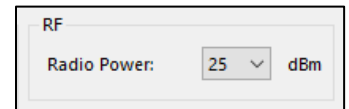

Reader section

This section modifies how the reader will read a tag.

Mode: Selects Timed or Trigger mode. In Timed mode, reads are performed at a constant interval. In Trigger mode, reads are only performed when the Trigger line is shorted to ground.

Timed Interval: The interval at which reads are performed. Minimum: 0.25 second, Maximum: 5 seconds.

Trigger Extension: Sets how long the Reader will remain active after the trigger is released. During this time, subsequent reads will be performed at the Timed Interval. Minimum: 0 seconds, Maximum: 10 seconds.

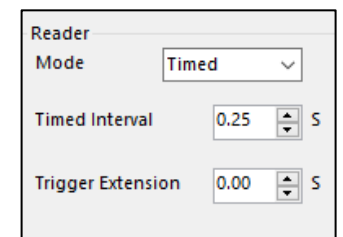

Serial Comm Section

Mode: Selects either standard ASCII (2 HEX character F/C and 4 characters ID) or HID Serial PROX reader output from a converted Wiegand Input.

RS-232:

Baud rate: Selections are 9600, 19200, 57600, 115200 (default).

RS-485 (Patriot E Only):

Baud rate: Selections are 9600, 19200, 57600, 115200 (default).

Protocol: Selects either the standard CR/LF output or the secure OSDP option.

The screenshot shows a configuration window titled "Serial Comm". It contains several dropdown menus: "Mode" is set to "ASCII"; "RS232 Baudrate" is set to "9600"; "RS485 Baudrate" is set to "9600"; "Protocol" is set to "CR/LF"; and "Address" is set to "Generic".

Wiegand Section

Allows modification of Wiegand settings. This is normally not necessary, but may be required with longer cable runs.

Output Mode(s): Select either “Wiegand + Serial” or just “Serial”.

Output Buffer: Sets an output buffer for 0...60 seconds. The output buffer adjusts how long the reader will ignore a specific tag after it is detected for the first time. For example, suppose the buffer is set to 10 seconds. If a tag is detected and its data outputted, then the reader will ignore that tag until at least 10 seconds have passed, even if the reader detects the tag multiple times before then.

Pulse Width: Sets the Wiegand Pulse Width from 20 μ S to 100 μ S.

Pulse Period: Sets the Wiegand Pulse Period from 200 μ S to 20000 μ S.

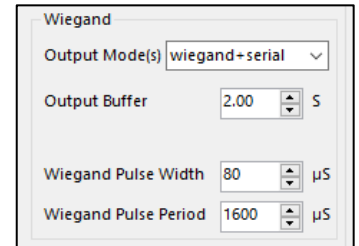

Tag Formats

The **Tag Formats** button allows selecting what tag formats will be decoded by the Patriot.

- **EMX** (always enabled) – 26-bit, 30-bit, 33-bit, 34-bit, 35-bit, and 37-bit tags manufactured by EMX
- **Alternate RFID Tag Compatibility** – In addition to EMX, one more RFID format can be selected. Tags with the selected format will have their EPC data decoded to Wiegand, and outputted on the Wiegand D0/D1 lines. As of v5.1.0, these formats are available:
 - Infinity RFID
 - Nedap
 - Rosslare
- **Generic** – When enabled, all Gen2 tags will be outputted over serial, TCP, and WiFi outputs as raw hexadecimal data, even if they don't contain Wiegand data. Useful for non-Wiegand applications of Gen2 RFID tags.

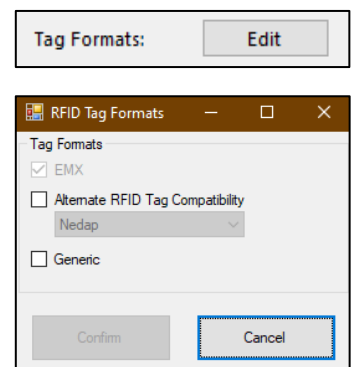

Tag Filtering Section

The Patriot reader is able to filter detected Wiegand tags based on two criteria: Facility Code and/or Tag ID. Tags that match the filter criteria will be outputted on the chosen output mode(s), and tags that do not match the filter criteria will be ignored by the reader.

Use Tag Filtering: If unchecked, then all valid Wiegand tags will be outputted by the reader, regardless of their Facility Code or Tag ID. If checked, then the Wiegand tags will be filtered according to the settings below. Tags can be filtered according to Facility Code, Tag ID, or both.

Facility Codes: Up to five distinct facility codes can be used for filtering. If a tag's Facility Code does not match any of the Facility Codes in the table, then the reader will ignore the tag. If the list of allowed Facility codes is empty, the reader will not use Facility Code as a filtering criterion, instead allowing tags with any Facility Code as long as they match the Tag ID criterion.

Tag IDs: Up to 100 distinct Tag IDs can be used for filtering. If a tag's ID does not match any of the Tag IDs in the table, then the reader will ignore the tag. If the list of allowed Tag IDs is empty, the reader will not use Tag ID as a filtering criterion, allowing tags with any Tag ID, as long as they match the Facility Code criterion.

To add Tag ID's to the list, click **Add**. Tag ID's can be entered individually, or as a range of data. A single number can be entered by just entering a number in the left box. You can also select the **Enter range of data** box and enter the starting ID then the ending ID to allow a range of Tag ID's. Once completed, press **OK** to save or **Cancel** to not save. Finally press **Send to Reader** to update the reader with the changes. When finished with this dialog, remember to store the changes to the reader by using the **'Set parameters'** button in the main window.

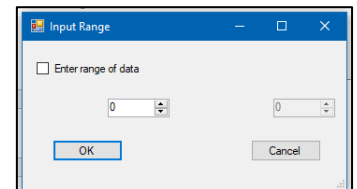
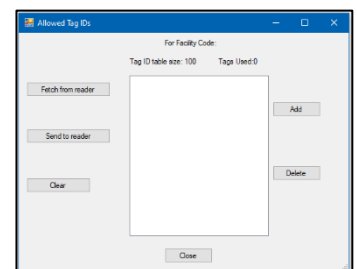
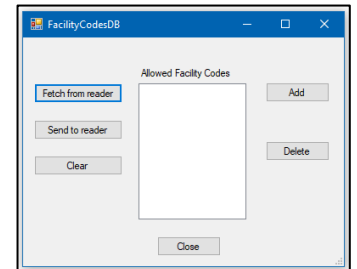
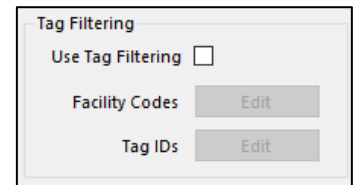

Relay

Enabled: Enables the relay driver output. If tag filtering is disabled, the relay driver output pulses high after any valid Wiegand input read. If tag filtering is enabled, the output will pulse high only when a tag matching the filter criteria is read.

Hold Time: Determines how long the relay output stays high. Range: 0 to 3 seconds.

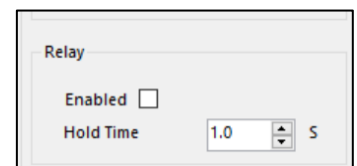

Indicators

LED: Enables and disables the LED for a valid read. The LED will illuminate whenever valid tag data is outputted by the reader. The LED will not illuminate if a tag is detected that does not meet the filter criteria, or if the tag's buffer timer has not expired. Default: Enabled.

Audio: Enables and disables the chime for a tag detection. The chime will sound whenever a tag is detected by the reader, regardless of whether it meets the filter criteria. If enabled, the audio will sound at most once per second, even if tags are detected more often. Default: Enabled.

LED Hold Time: Sets how long the LED remains on after a valid read. Range: 0 to 3 seconds.

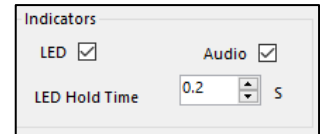

Log Window

Displays every GEN2 tag detected, regardless of facility code. This window is typically used for troubleshooting.

Pause: Stops updating the log window.

Clear: Clears the log window.

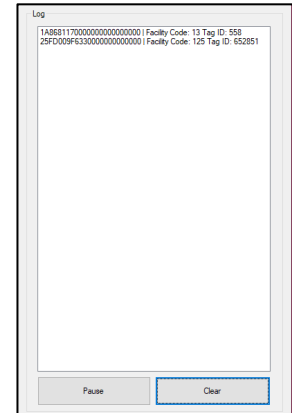

Wired Ethernet Configuration (E.TCP, L.TCP only)

Note: This procedure requires a PC that is not connected to any other network. The IP address will be configured manually. If needed, it's possible to use a network-connected PC, reconfigure it for this test, and then switch back to the network connection when finished.

Note: DHCP is not supported.

1. Press the “Windows” button on your keyboard and then type “Network Status”. Click on the “Network Status” app to display the following window:

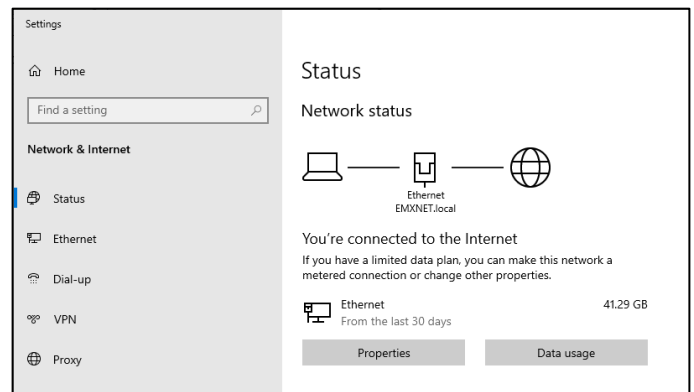

2. In the left hand pane, select “Ethernet” and the following window will be displayed:

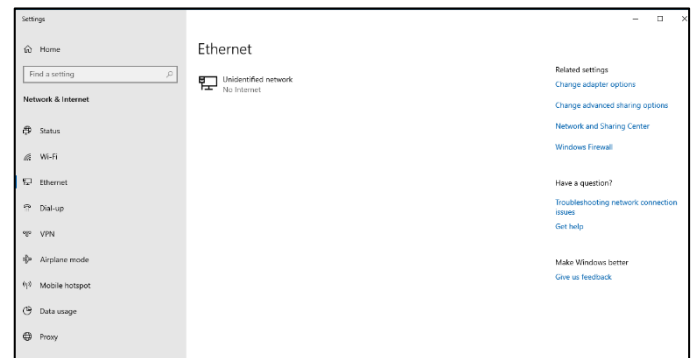

3. Select “Change adapter options” in the right-hand pane. You will then see the following window:

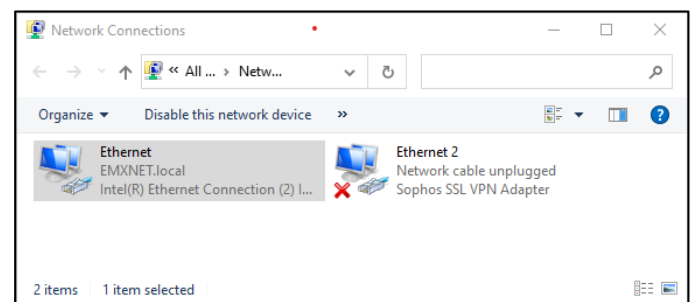

4. Select the 'Ethernet' icon to display the following pop-up window:

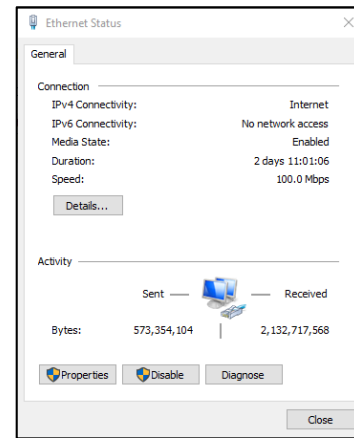

5. Select "Properties" to display the following window:

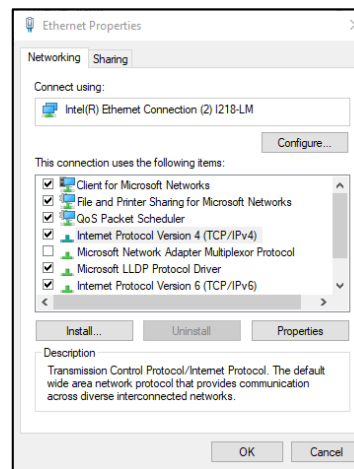

6. Select "Internet Protocol Version 4 (TCP/IPv4)" and click on "Properties" to display the following window and enter the information as shown:

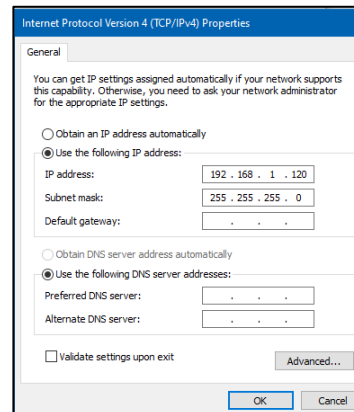

7. Click "OK" to save your changes

You are finished setting up the IP configuration on your computer. You can now configure the Reader. You will need to connect to the Reader through the RS-232 port to configure the Ethernet connection, so **connect using the TRES Reader Setup software:**

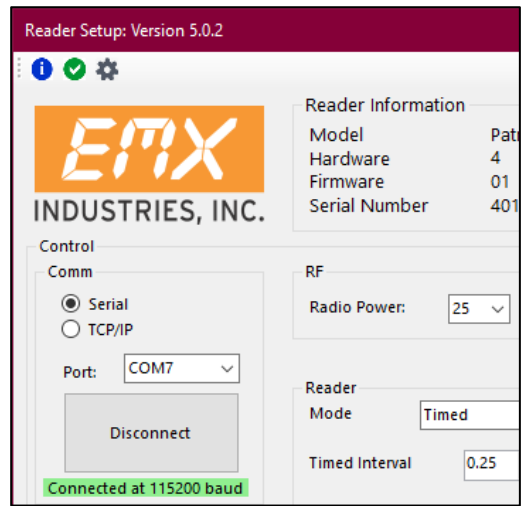

8. Once connected, select the options icon (the gear in the upper left of the screen) and you will see the following options:

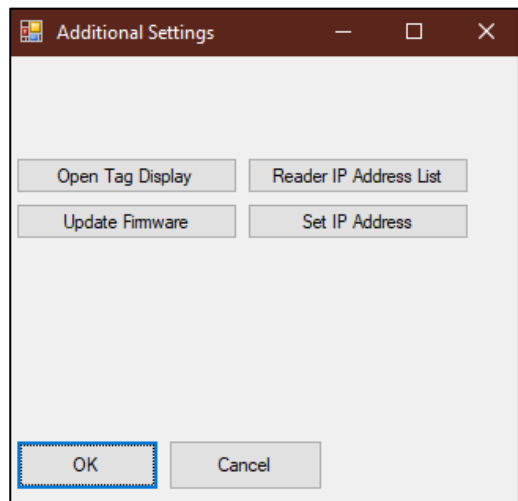

9. Click "Reader IP Address List" to display the following window:

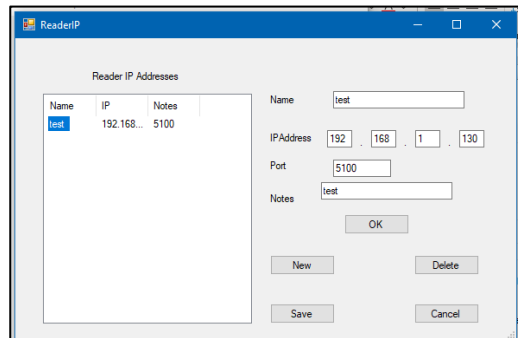

10. Click "New" and enter the settings as shown above. Once entered, click "OK" then click "Save". You will then be returned to the following screen:

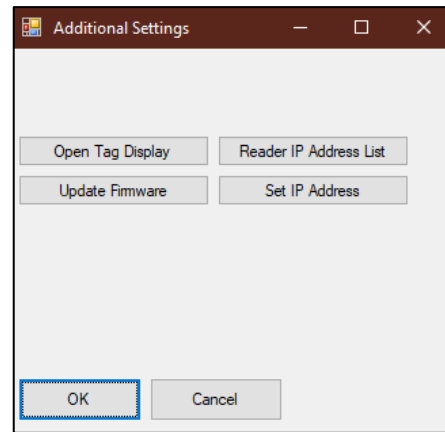

11. Select "Set IP Address". You will see the following screen:

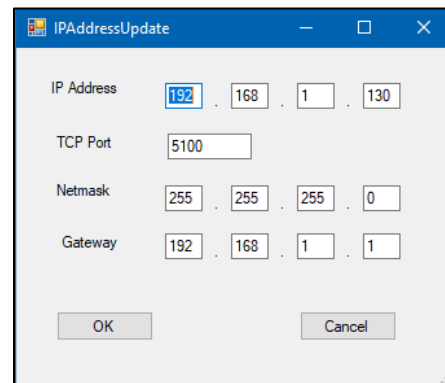

12. Populate the fields as shown above, then click "OK". Finally, click "OK" on the previous screen. Wait a few seconds and then click "Restart".

13. When the Reader has restarted, connect to it using the Reader Setup software over TCP/IP (select the "test" connection in the dropdown menu).

14. To test, bring a tag within range of the Reader and verify that the Log window updates with the tag data every 2 seconds. If so, configuration is complete.

15. Press the “Windows” button on your keyboard and then type “Network Status”. Click on the “Network Status” app to display the following window:

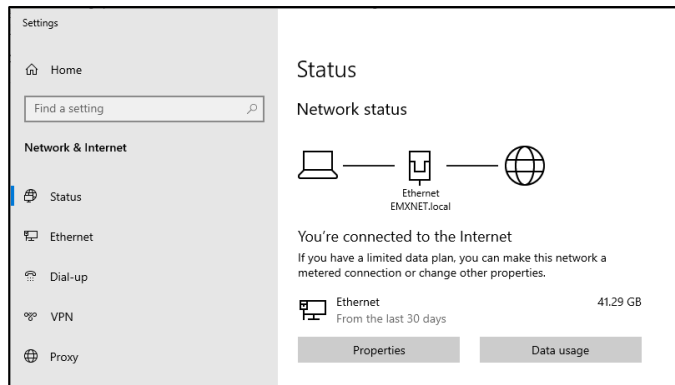

16. In the left hand pane, select “Ethernet” and the following window will be displayed:

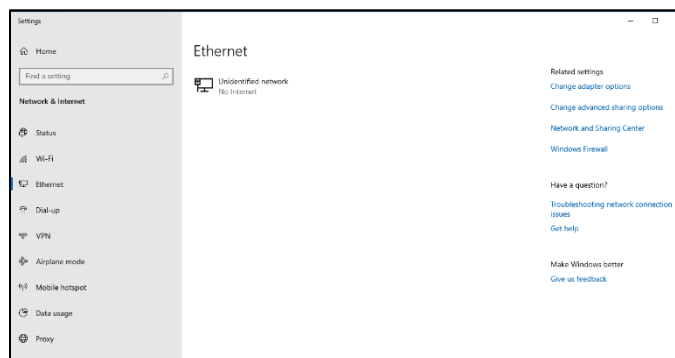

17. Select “Change adapter options” in the right-hand pane. You will then see the following window:

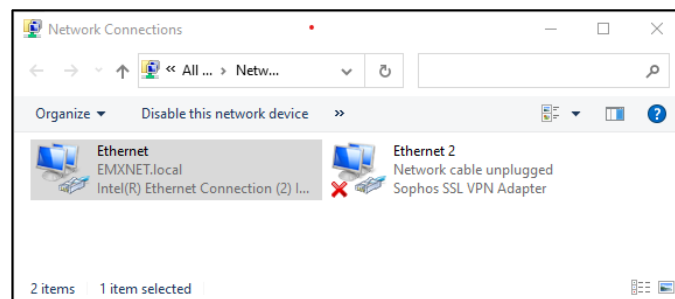

18. Select the 'Ethernet' icon to display the following pop-up window:

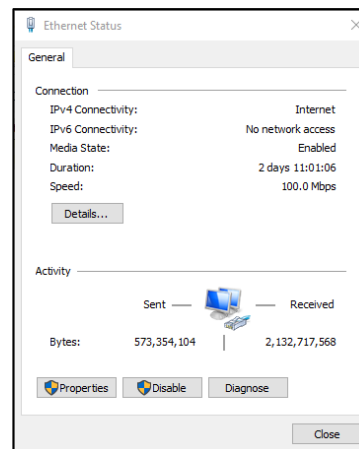

19. Select "Properties" to display the following window:

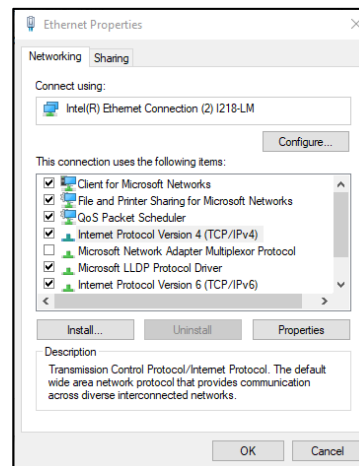

20. Select "Internet Protocol Version 4 (TCP/IPv4)" and click on "Properties" to display the following window and enter the information as shown:

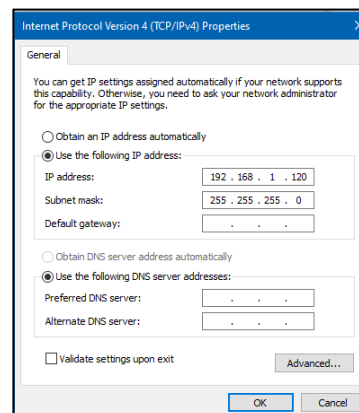

21. Click "OK" to save your changes

You are finished setting up the IP configuration on your computer. You can now configure the Reader. You will need to connect to the Reader through the RS-232 port to configure the Ethernet connection, so **connect using the TRES Reader Setup software:**

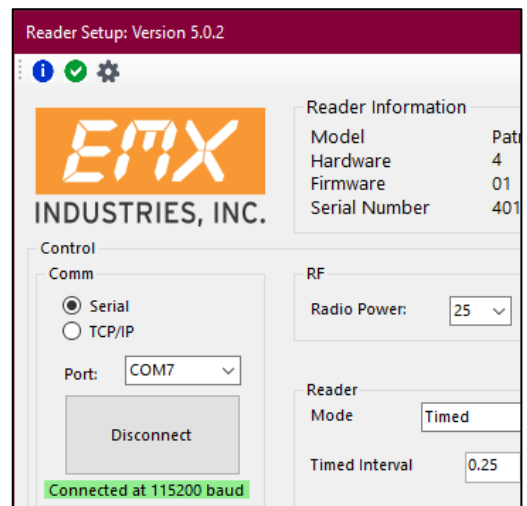

22. Once connected, select the options icon (the gear in the upper left of the screen) and you will see the following options:

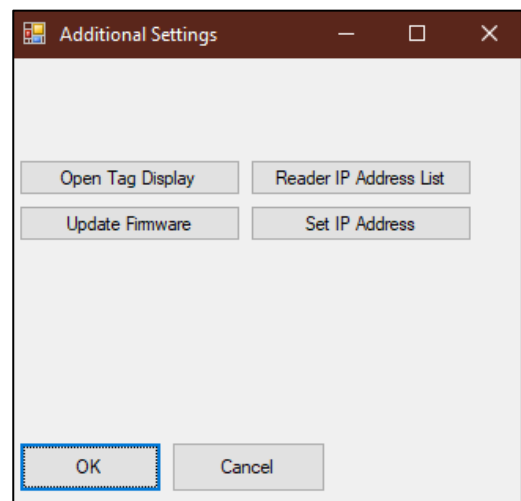

23. Click "Reader IP Address List" to display the following window:

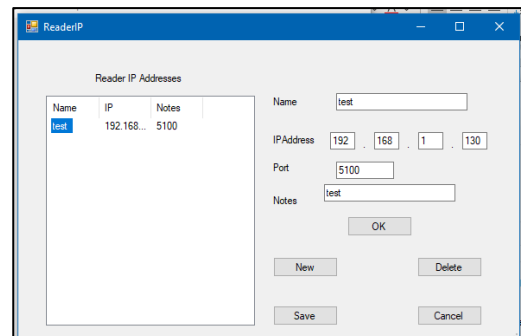

24. Click "New" and enter the settings as shown above. Once entered, click "OK" then click "Save". You will then be returned to the following screen:

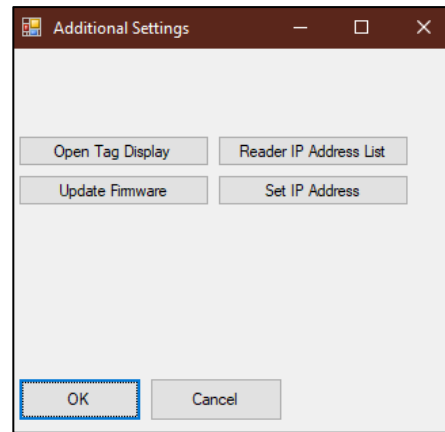

25. Select "Set IP Address". You will see the following screen:

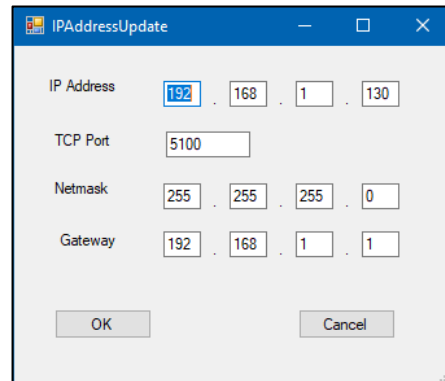

26. Populate the fields as shown above, then click "OK". Finally, click "OK" on the previous screen. Wait a few seconds and then click "Restart".

27. When the Reader has restarted, connect to it using the Reader Setup software over TCP/IP (select the "test" connection in the dropdown menu).

28. To test, bring a tag within range of the Reader and verify that the Log window updates with the tag data every 2 seconds. If so, configuration is complete.

29. Press the “Windows” button on your keyboard and then type “Network Status”. Click on the “Network Status” app to display the following window:

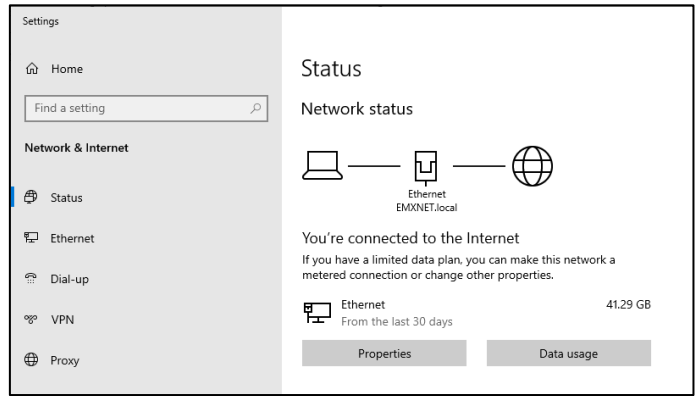

30. In the left hand pane, select “Ethernet” and the following window will be displayed:

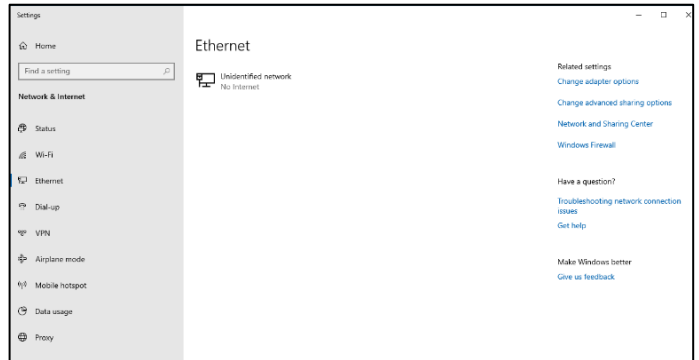

31. Select “Change adapter options” in the right-hand pane. You will then see the following window:

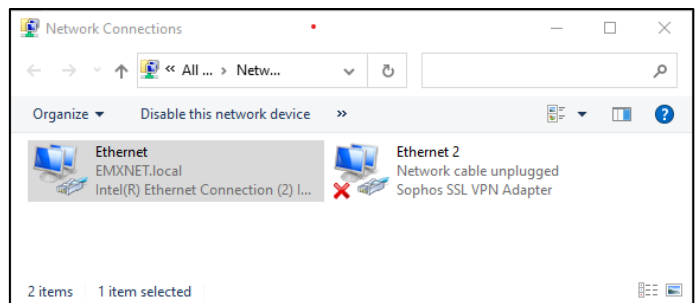

32. Select the 'Ethernet' icon to display the following pop-up window:

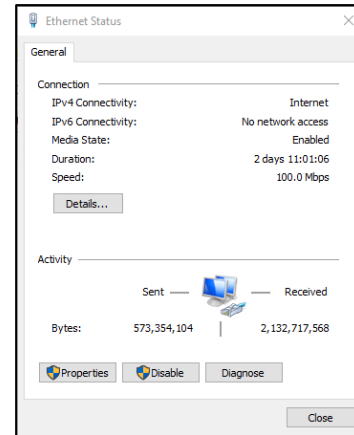

33. Select "Properties" to display the following window:

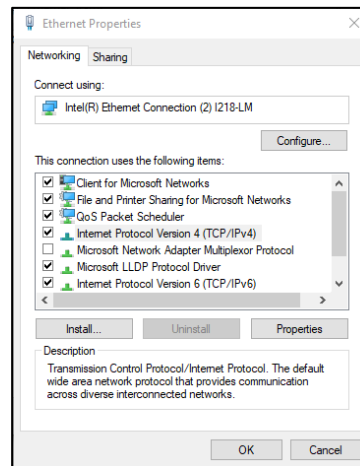

34. Select "Internet Protocol Version 4 (TCP/IPv4)" and click on "Properties" to display the following window and enter the information as shown:

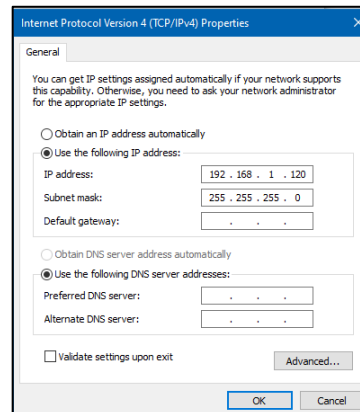

35. Click "OK" to save your changes

You are finished setting up the IP configuration on your computer. You can now configure the Reader. You will need to connect to the Reader through the RS-232 port to configure the Ethernet connection, so **connect using the TRES Reader Setup software:**

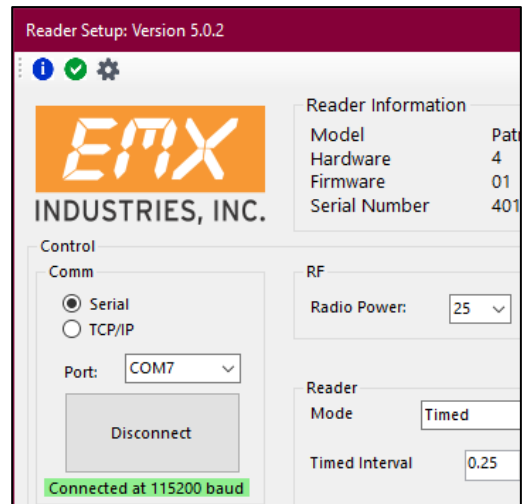

36. Once connected, select the options icon (the gear in the upper left of the screen) and you will see the following options:

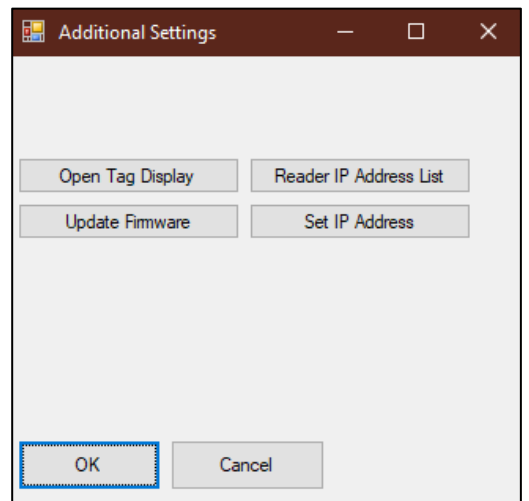

37. Click "Reader IP Address List" to display the following window:

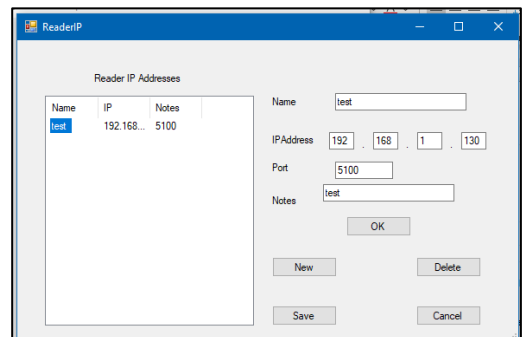

38. Click "New" and enter the settings as shown above. Once entered, click "OK" then click "Save". You will then be returned to the following screen:

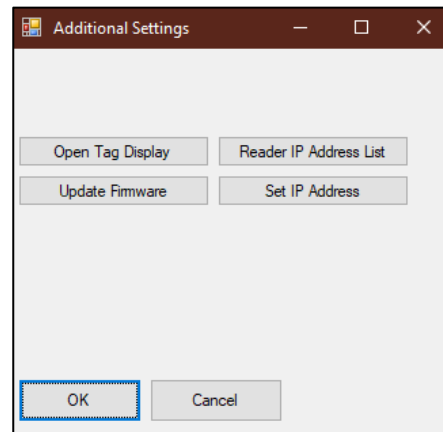

39. Select "Set IP Address". You will see the following screen:

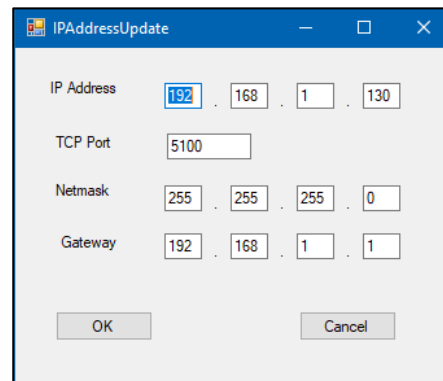

40. Populate the fields as shown above, then click "OK". Finally, click "OK" on the previous screen. Wait a few seconds and then click "Restart".

41. When the Reader has restarted, connect to it using the Reader Setup software over TCP/IP (select the "test" connection in the dropdown menu).

42. To test, bring a tag within range of the Reader and verify that the Log window updates with the tag data every 2 seconds. If so, configuration is complete.

43. Press the “Windows” button on your keyboard and then type “Network Status”. Click on the “Network Status” app to display the following window:

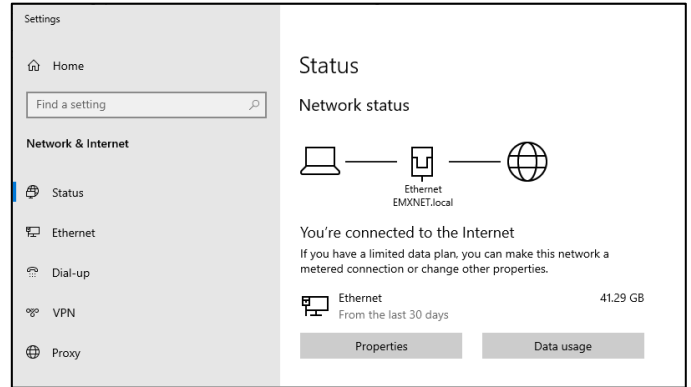

44. In the left hand pane, select “Ethernet” and the following window will be displayed:

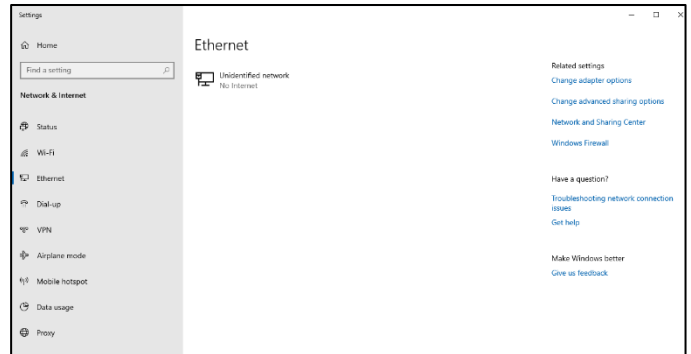

45. Select “Change adapter options” in the right-hand pane. You will then see the following window:

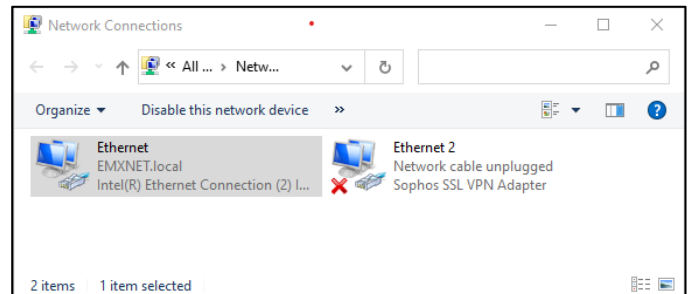

46. Select the 'Ethernet' icon to display the following pop-up window:

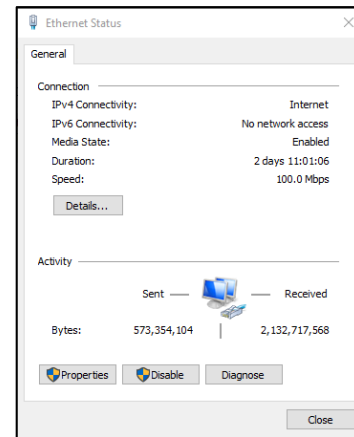

47. Select "Properties" to display the following window:

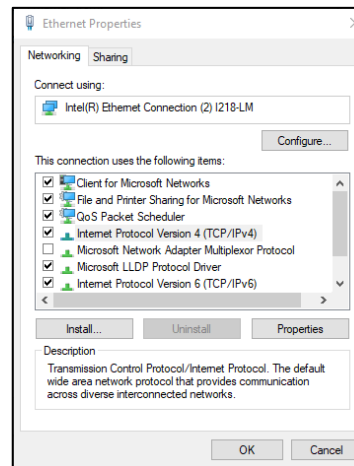

48. Select "Internet Protocol Version 4 (TCP/IPv4)" and click on "Properties" to display the following window and enter the information as shown:

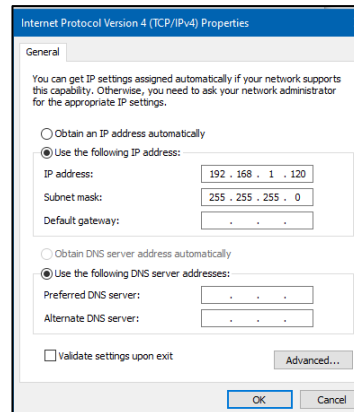

49. Click "OK" to save your changes

You are finished setting up the IP configuration on your computer. You can now configure the Reader. You will need to connect to the Reader through the RS-232 port to configure the Ethernet connection, so **connect using the TRES Reader Setup software:**

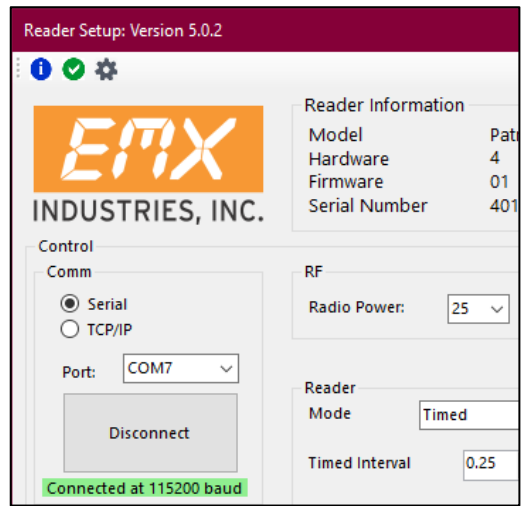

50. Once connected, select the options icon (the gear in the upper left of the screen) and you will see the following options:

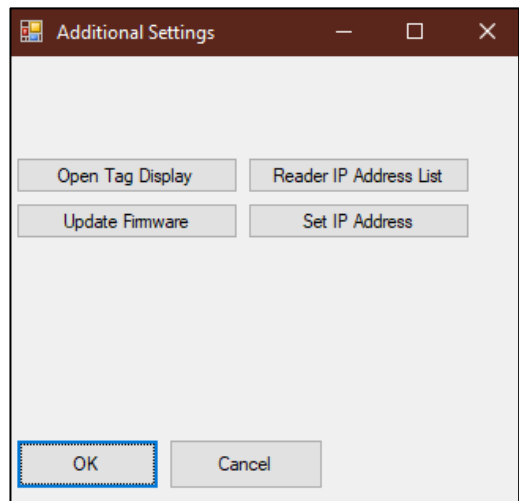

51. Click "Reader IP Address List" to display the following window:

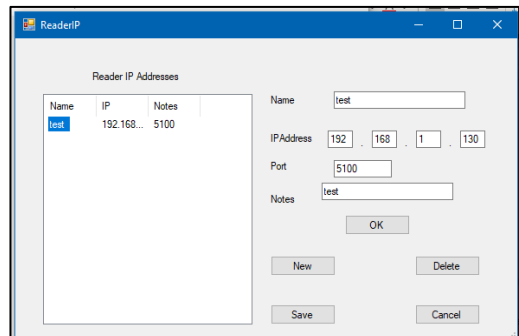

52. Click "New" and enter the settings as shown above. Once entered, click "OK" then click "Save". You will then be returned to the following screen:

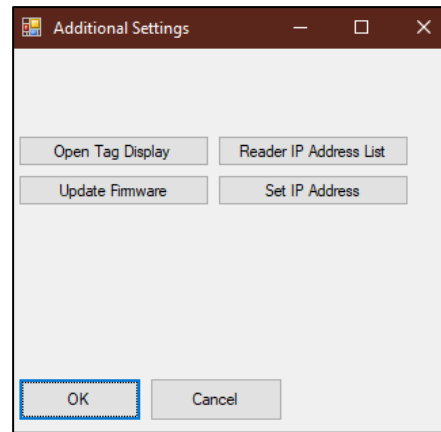

53. Select "Set IP Address". You will see the following screen:

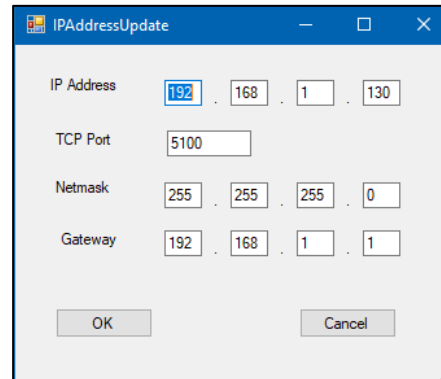

54. Populate the fields as shown above, then click "OK". Finally, click "OK" on the previous screen. Wait a few seconds and then click "Restart".

55. When the Reader has restarted, connect to it using the Reader Setup software over TCP/IP (select the "test" connection in the dropdown menu).

56. To test, bring a tag within range of the Reader and verify that the Log window updates with the tag data every 2 seconds. If so, configuration is complete.

Wi-Fi Configuration (E.WiFi, L.WiFi only)

Access Point (Default)

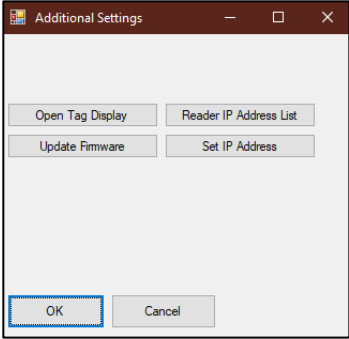
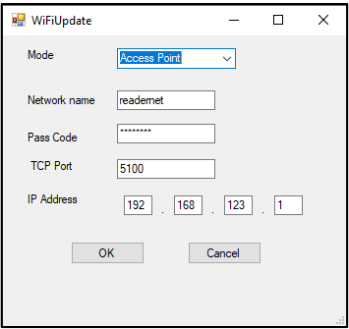
<p>1. Connect to the Reader over Serial using the Reader Setup software. Then click the “gear” icon. You will see the following window:</p>	
<p>2. Click “Set IP Address”. You will then see this window:</p>	
<p>3. Select “Access Point” from the “Mode” dropdown menu. Then populate the remaining fields as desired.</p> <p><i>The default settings are provided here, but we highly recommend that you change these settings to fit your application, especially the passcode, to prevent unauthorized access to the settings.</i></p>	<p>Default Settings:</p> <ul style="list-style-type: none">• Network name: readernet• Pass Code: reader123• TCP Port: 5100• IP Address: 192.168.123.1
<p>4. Click “OK”, then click “OK” on the “Additional Options” screen. Wait for a few seconds and then click “Restart”. When the Reader has restarted, use your PC Wi-Fi settings to connect to the network name you chose (default: readernet). Use your passcode to connect. (Default: reader123)</p>	
<p>5. Once connected, use the Reader Setup software to connect to the reader over TCP/IP (select “readernet” from the dropdown menu).</p>	
<p>6. Bring a tag within range of the reader and verify that the Log window is updating with tag data every 2 seconds. If so, configuration is complete.</p>	

Station

In Station mode, the Patriot reader can connect to an existing Wi-Fi network. To configure the Patriot reader in this way using the Wi-Fi Update screen:-

1. Select "Station" from the "Mode" dropdown menu.

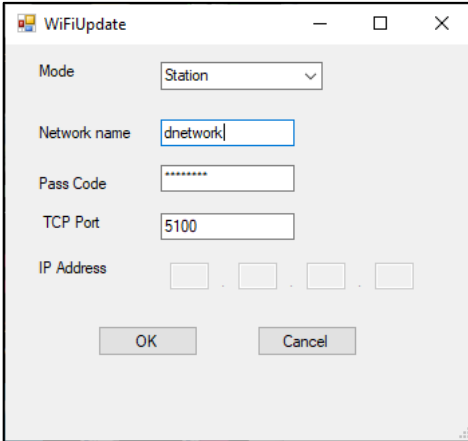

The screenshot shows a dialog box titled "WiFiUpdate". It has a "Mode" dropdown menu set to "Station". Below it are four input fields: "Network name" with the text "dnetwork", "Pass Code" with seven asterisks, "TCP Port" with the value "5100", and "IP Address" which is empty and appears to be a read-only field with four small boxes separated by dots. At the bottom of the dialog are two buttons: "OK" and "Cancel".

2. Populate the remaining fields as follows:

- a. **Network name:** This is the name (SSID) of the existing Wi-Fi network.
- b. **Pass Code:** This is the pass code to connect to the existing network.
- c. **TCP Port:** This is the TCP port number that the reader will listen on for setup connections. (Default: 5100)

IP Address: This field is read only. It will show the IP address that has automatically been assigned to the reader via the existing Wi-Fi network.

3. Click "OK", then click "OK" on the "Additional Options" screen. Wait for a few seconds and then click "Restart" to restart the reader.

OSDP Configuration (Patriot E Only)

1. Wire the reader to an OSDP controller per the pigtail cable wiring diagram: Violet is GND, Tan is T/R+ (485A) and Pink is T/R- (485B).

2. Connect to the reader using the Reader Setup software.

a. *Note: it is not possible to configure the Patriot via RS-485. Instead, you must connect to the reader setup software using RS-232, Ethernet, or Wi-Fi*

3. Change the RS-485 protocol to "OSDP" in the "Protocol" dropdown menu. Set the Baudrate and Address fields as desired. See the screenshot:

When finished, remember to click "Set Parameters" to save all changes.

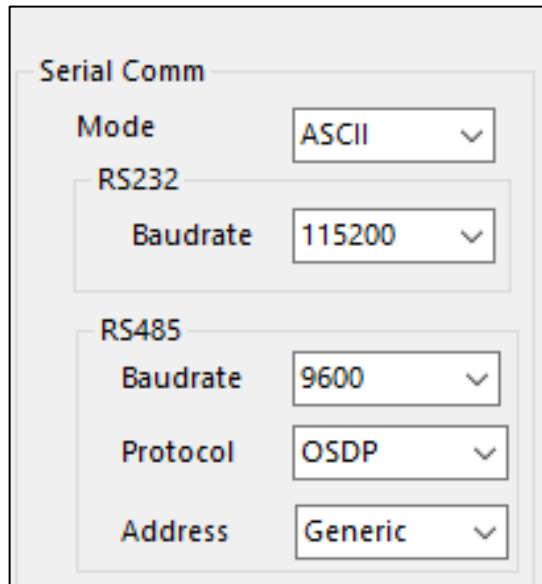

Serial Comm

Mode: ASCII

RS232

Baudrate: 115200

RS485

Baudrate: 9600

Protocol: OSDP

Address: Generic

4. Click the "gear" icon in the upper left corner of the Reader Setup screen. You will see the following window:

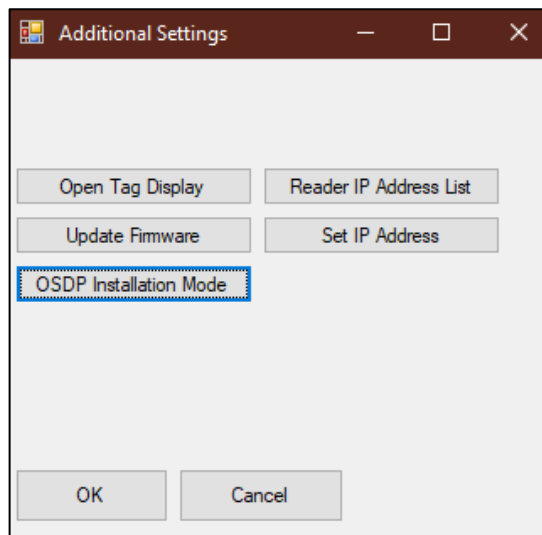

Additional Settings

Open Tag Display

Reader IP Address List

Update Firmware

Set IP Address

OSDP Installation Mode

OK

Cancel

5. Click the 'OSDP Installation Mode' button. This will sync your controller and reader for either secure or non-secure modes.

6. Press the 'OK' button and disconnect from the Reader Setup software. Test the OSDP link by reading a tag to verify proper operation.

Troubleshooting

Symptom	Possible Causes	Solution
Reader beeps repeatedly without outputting any tag data	Reader has insufficient power	Make sure that the power supply is able to handle the max current (1.86A) of the reader. Check the wire gauge to the reader.
Reader does not recognize a specific tag (no beep, no tag data)	Damaged tag Tag filtering is excluding tag	Verify functionality with another tag. If tag filtering is enabled in the setup software, ensure that the problematic tag would be accepted.
Reader does not recognize any tags (no beep, no tag data)	Reader is set to "Triggered" mode instead of "Timed" Tag filtering enabled with mismatched settings. Incompatible tag.	Try connecting the blue trigger wire to ground. If the reader reads tags now, then the reader is configured for "Triggered" mode. Switch the reader to "Timed" mode using the setup software, or connect the blue trigger wire to ground to initiate a read. Disable tag filtering, or change the settings so that the tags will be read. Make sure you are using tags that are compatible with the Patriot.
Tag data to panel is scrambled or missing, or Reader beeping and host not responding	One or more of the reader's wiring connections is incorrect. Cable between reader and panel is too long Missing Wiegand GND connection	Verify the wiring connections. Check that Data 0, Data 1 and ground are properly attached. Also make sure that the Data 0 and Data 1 wires have not been swapped. Use shorter cables for the reader connections. Connect the Wiegand-GND (Gray) wire to a Control Panel GND terminal.
Read range too short for a specific tag	Tag detuned by incompatible material (metal, skin, liquid) Poor tag placement	Make sure that your tag is mounted on a material it is designed for, typically glass or open air. Tags will have decreased range when mounted near metal or liquid, or when near skin. If you are holding the tag in your hand, hold it by the edges so that your skin does not detune the tag's antenna. Tag should be facing the Reader Antenna (Parallel Surface Rule) for maximum performance and distance. Tag orientation must also match the reader orientation for the linear-polarized Patriot L.

Read range too short for all tags	<p>RF power too low</p> <p>Poor reader placement</p> <p>Reader antenna detuned by nearby material</p> <p>Ground loop</p>	<p>Increase the RF power using the reader setup software.</p> <p>Consult the reader installation guide for optimal reader placement.</p> <p>Make sure that the front of the reader is positioned far (18" recommended) from any nearby body parts, metals, or liquids, then restart the reader.</p> <p>Check by powering reader without V- wire connected. If the Reader turns on, Earth GND and V- must be tied together elsewhere in the system. Find this point and disconnect the two. Earth ground should terminate only at the Reader.</p>
Read range is long enough, but read zone is inconsistent, with "dead spots"	RF signal reflections and multipathing	In some environments, especially indoors or in small spaces, RF signal reflections from walls and floors can cause dead spots in the read zone. You may try decreasing the radio power slightly to mitigate this.

Do's and Do Not's

Do not put another manufacturer's Wiegand reader output wires on the same terminal of the controller as the Patriot E / Patriot L reader unless you use a Wiegand splitter.

- Do not mount the reader too close to concrete walls or metal surfaces. This could lead to poor signal quality.
- Do use the included EMX power supply
- Do use appropriate wire gauges.
- Do mount tags in a vertical orientation and test first before applying permanently.
- Do test the reader in-house before mounting it at a jobsite.
- (E.WiFi, L.WiFi) Do change the access point password away from the default password to prevent unauthorized access to the settings.

Warranty

EMX Industries, LLC dba EMX Industries, Inc. and its subsidiaries and affiliates (collectively, "EMX") warrants to the original purchaser ("you", "your" or "Purchaser") that its products ("Products") are free from material defects in material and workmanship for a period of two (2) years from the date of manufacture of the Products (evidenced by EMX's product manufacture date code) (the "Limited Warranty Period").



Your sole and exclusive remedy and EMX's sole obligation for any Products that are nonconforming when delivered to you, or are found to be defective during the Limited Warranty Period, will be, in EMX's sole discretion, to replace the nonconforming or defective Product or provide you with a credit equal to the purchase price of the nonconforming or defective Product. This warranty does not cover labor or other costs or expenses to remove or install any defective, repaired, or replaced Products.

Except as provided under Section 3 of EMX's Terms and Conditions of Sale (which can be found at <https://www.emxaccesscontrolsensors.com/terms>) (the "Terms"), which Terms are incorporated herein by reference, all sales of Products to Purchaser are made on a one-way basis and Purchaser has no right to return Products to EMX. This warranty extends only to the original Purchaser and is not transferable under any circumstances. If the Products are gifted or resold, all warranty claims must be resolved through the original Purchaser. EMX will not handle claims from end-users directly.

1. You must notify EMX in writing within the Limited Warranty Period if you discover that a Product is nonconforming or defective, and you must also contact EMX technical support staff at 216-518-9889 and provide a description of the nonconformity or defect together with written evidence or other documentation as required by EMX. If EMX determines that the Product is nonconforming or defective and the claim is made within the Limited Warranty Period, EMX will instruct you to either dispose of or return the nonconforming or defective Product to EMX together with the EMX RMA number. No Product returns will be accepted without an EMX approved RMA number. Returned Products must be sent to EMX's designated facility at Purchaser's expense and risk of loss. If EMX exercises its option to replace nonconforming or defective Products, EMX shall, after receiving Purchaser's shipment of such returned nonconforming or defective Products, deliver the replacement Products in accordance with Section 4 of the Terms.
2. This limited warranty does not cover and EMX will have no obligation to replace any Product if (i) Purchaser or any end-user makes any further use of such Products after giving notice that such Product is nonconforming or defective, (ii) replacement is required as a result of normal wear and tear, or causes external to the Product, (ii) the Product has been altered other than by an authorized EMX representative, (iii) the Product has not been properly installed, handled, used, maintained, modified or adjusted; or (iii) the replacement is requested after the Limited Warranty Period has expired.
3. EMX shall not be liable for a breach of the warranty set forth in paragraph a. unless: (i) Purchaser gives written notice of the defect, reasonably described, to EMX within five (5) days of the time when Purchaser or any end-user discovers or ought to have discovered the defect; (ii) EMX is given a reasonable opportunity after receiving the notice to examine such Products and Purchaser (if requested to do so by EMX) returns such Products to EMX's place of business at Purchaser's cost for the examination to take place there; and (iii) EMX reasonably verifies Purchaser's claim that the Products are defective.
4. **EXCEPT FOR THE WARRANTY SET FORTH IN SUBPART (a) ABOVE, EMX MAKES NO REPRESENTATION OR WARRANTIES WHATSOEVER WITH RESPECT TO THE PRODUCTS, WHETHER EXPRESS OR IMPLIED BY LAW, INCLUDING, WITHOUT LIMITATION, ANY WARRANTY OF MERCHANTABILITY, FITNESS FOR A PARTICULAR PURPOSE, TITLE, NON-INFRINGEMENT, OR ARISING FROM COURSE OF DEALING, COURSE OF PERFORMANCE, USAGE OF TRADE OR OTHERWISE, ALL OF WHICH EMX HEREBY EXPRESSLY DISCLAIMS.**
5. EMX reserves the right to change, modify or improve the design of the Product without assuming any obligations or liabilities relating to any Product previously manufactured by EMX.
6. Products manufactured by a third party ("Third Party Product") may constitute, contain, be contained in, incorporated into, attached to or packaged together with, the Products. Third Party Products are not covered by the warranty in subpart (a) above. For the avoidance of doubt, **EMX MAKES NO REPRESENTATIONS OR WARRANTIES WHATSOEVER WITH RESPECT TO ANY THIRD PARTY PRODUCT, WHETHER EXPRESS OR IMPLIED BY LAW, INCLUDING, WITHOUT LIMITATION, ANY WARRANTY OF MERCHANTABILITY, FITNESS FOR A PARTICULAR PURPOSE, TITLE, NON-INFRINGEMENT, OR ARISING FROM COURSE OF DEALING, COURSE OF PERFORMANCE, USAGE OF TRADE OR OTHERWISE, ALL OF WHICH EMX HEREBY EXPRESSLY DISCLAIMS.]**

EMX's full Terms and Conditions of Sale can be found at <https://www.emxaccesscontrolsensors.com/terms>) and are incorporated herein by reference.

Manual Revision History

- Rev A 09/30/21 - First draft combining all 3 readers by RL
- Rev B 04/12/22 - Updated to reflect new name and features for each Patriot reader by RL
- Rev C 07/28/23 – Updated for EMX use by PB
- Rev 1.0 09/25/24 – Updated for new firmware v5.0.1 and Setup Software v5.0.2 by CH
- Rev 1.1 11/06/24 – Updated Tag orientation section
- Rev 1.4 10/09/25 – Updated for new firmware v5.1.0 and Setup Software v5.1.0 by CH